

Technical information

Dimensions

Imperial

Metric

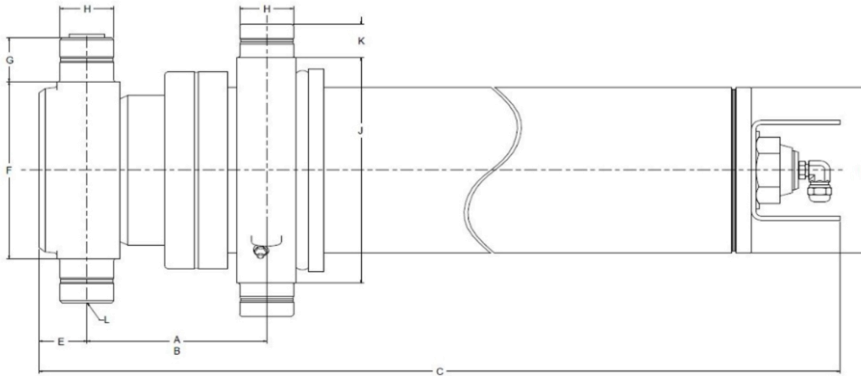

Dimensions	Imperial	Metric
A (stroke)	97,44 in	2 475 mm
B (closed)	5,25 in	133 mm
C	47,94 in	1 218 mm
D	5,56 in	141 mm
E	2,00 in	51 mm
F	5,75 in	146 mm
G	2,00 in	51 mm
H	1,88 in	48 mm
J	8,00 in	203 mm
K	1,25 in	32 mm
L	SAE-12	
M		
N		

Stage	Effective diameter		Effective area		Stroke	
1	4,500 in	114 mm	15,90 in ²	10 261 mm ²	32,31 in	821 mm
2	3,750 in	95 mm	11,04 in ²	7 126 mm ²	32,50 in	826 mm
3	3,000 in	76 mm	7,07 in ²	4 560 mm ²	32,63 in	829 mm

Specifications	Imperial	Metric
Weight without hydraulic fluid	219 lb	100 kg
Hydraulic fluid volume	5,3 gal. (US)	20 l
Maximum working pressure	2 500 psi	172 bar
Maximum pump flow ext. (retract.)	25 gpm (0 gpm)	95 lpm (0 lpm)
Cylinder design limit capacity*	23,4 US tons	21 228 kg

Installation components	Model	Part no.
Block	B-1875	PB3005002-A
Frame	AC-4024	PF3000012
Hinge	P-200	PP3004010

Cylinder capacity

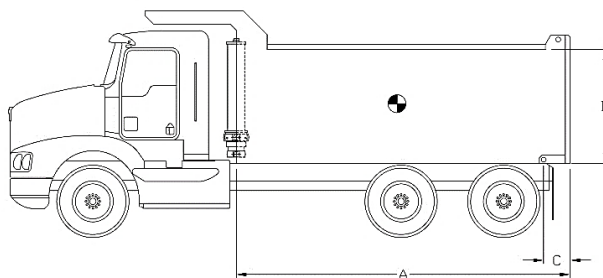

A = Body Length
 B = Body height
 C = Overhang

Note:	Body length	10,5 ft		11,5 ft			
	Cylinder capacities based on 90% of the maximum working pressure.	Overhang	0 in	6 in	12 in	18 in	
Dump angle		45,7°	48,1°	45,7°	48,1°		
Body height		Capacities for different box length configuration in US tons at 2000 psi (at 2500 psi)					
For reference only. See www.mailhotindustries.com	36 in	16,9 (21,1)	18,6 (23,3)	19,0 (23,8)	21,4 (26,8)		
	48 in	18,1 (22,6)	20,2 (25,3)	20,6 (25,7)	23,6 (29,5)		
	60 in	19,4 (24,3)	22,1 (27,7)	22,3 (27,9)	26,2 (32,8)		

* See product manual

Subject to change without notice, all rights reserved.

REV 1A

Item	Part no.	Description
1	ROVD051044-A	BASE TUBE Ø5,06
2	RMGD042286-A	SECTION Ø4-1/4
3	RMGD035287-A	SECTION Ø3-1/2
4	RNVD025089-A	LAST SECTION Ø2-1/2
7	RK056134-A	COVER TUBE ASSEMBLED
8	RFG046031	END CAP Ø4-5/8
9	RFG046032	END CAP Ø4-5/8

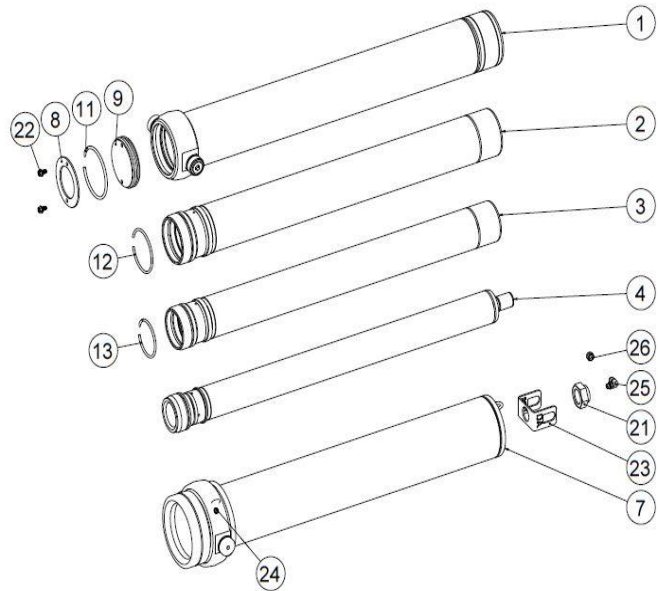

Snap ring kit Part no. : XB19G0423

Item	Description
11	SNAP RING Ø4-5/8
12	SNAP RING Ø3-3/4
13	SNAP RING Ø3-3/4

Hardware kit Part no. : ZX02G0423D

Item	Description
21	STOVER NUT 1-1/4-12 UN GRADE C
22	SERRATED FLANGE HSS GRADE 5 Ø3/8-16 UNC X 3/4 LG
23	PROTECTOR
24	GREASE FITTING STRAIGHT 1/8 NPT
25	ELBOW ADAPTER 90° ORB TO 37° FLARE
26	CAP NUT 37° FALRE Ø3/4-16
27	RELIEF VALVE PRESET 3200 PSI (3000-3500 PSI)

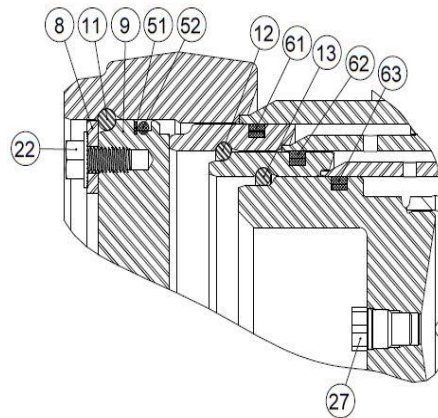

Seal kit Part no. : UI47G0423D

Item	Description
31	UCUP DZ Ø4-5/8 X Ø4-1/4 X 3/8
32	UCUP DZ Ø3-7/8 X Ø3-1/2 X 3/8
33	UCUP DZ Ø3 X Ø2-1/2 X 3/8
41	WIPER DT Ø4-1/4
42	WIPER DT Ø3-1/2
43	WIPER DT Ø2-1/2
51	BACKUP RING Ø4-5/8 X Ø4-1/4
52	O-RING Ø4-5/8 X Ø4-1/4
61	PISTON RING Ø4-1/2
62	PISTON RING Ø3-3/4
63	PISTON RING Ø3

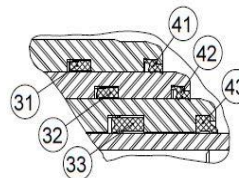

* See product manual

Subject to change without notice, all rights reserved.

REV 1A